

INSTALLATION GUIDE: SINGLE HOLE MOUNTED LAVATORY FAUCET

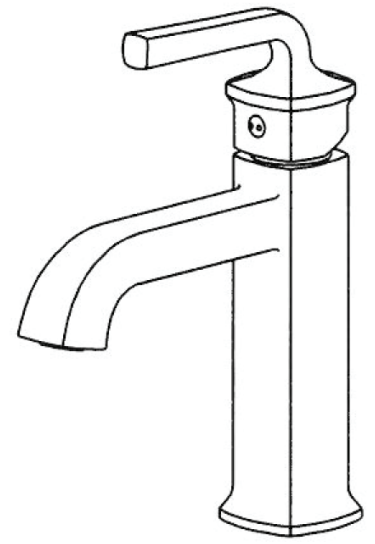

PRODUCT SPECS AND STANDARDS:

DESCRIPTION:

- Cast brass body with 1/2" IPS threads
- Surface thickness 1-1/2" maximum
- One (1-/18" min to 1-1/2" min max)

OPERATION:

- Requires less than 5LB force to operate valve
- 1.2 GPM (4.5 L/min) Aerator

STANDARDS:

- IAPMO/UPC Certified:
- ASME A112.18.1-2012/CSA B 125.1-12
- NSF/ANSI 61-2012
- NSF/ANSI 372-2011 (Lead Free)
- Watersense approved

WARRANTY:

- 25 Year drip-free warranty
- Product to be free of defects in material or workmanship

CLEANING INSTRUCTIONS:

Use only a clean, soft cloth, water, and mild hand soap to clean unit.

WARNING: Do NOT use abrasive cleaners, chemicals, or abrasive cleaning pads to clean fixture. A very hard protective coating has been applied to this product to maintain it's appearance, but this product could be damaged with improper cleaning. Failure to follow cleaning instructions will void product warranty.

NOTE:

While your faucet may differ in appearance to item shown, it will install with in the same manner.

PRODUCT WARRANTY:

Windon Bay faucets have been manufactured to our high quality standards and workmanship. **The warranty covers defects in materials and/ or workmanship to the original purchaser/home owner (warranty is not transferable to another person).** The faucet is warranted to remain drip-free during normal use. All parts and finishes will be free from manufacturing defects. With the exception of items listed below, this product has a limited warranty against defects in materials or workmanship for a period of 1 year from the date of purchase. The warranty is voided if the product is found to be misused or the following cleaning instructions were not followed. Damage due to accidents or installation is not warranted.

1. Faucet valve cartridges have a limited warranty for a period of 25 years from the date of purchase. This date is stamped on the valve cartridge.
2. Product finish has a limited warranty for a period of 25 years from the date of purchase. Failure to follow the cleaning instructions listed below voids all finish warranty. Damage due to accidents or installation is not warranted.

This warranty covers replacement of cartridges, parts and finish only. It does not include labor charges and/or damage incurred during installation. Windon Bay will provide free of charge all parts and cartridges found to be covered under the warranty; any part that proves defective in material and/or workmanship under normal installation, use and service. Finish warranty is not covered if finish is exposed to extreme use of cleaners containing abrasives and alcohol, extreme cleaning, extreme chemical use, or any damage due to abuse or neglect (Oil Rubbed Bronze and Matte Black finish is warranted for 1 year).

**Please see cleaning instructions provided with each faucet. This warranty excludes all industrial, commercial, and business usage of faucets and only pertains to single dwelling residential use. Faucets used for other than single dwelling residential use are covered by a 1-year limited warranty from the date of purchase.

HELPFUL TOOLS

Slip Joint Wrench



Adjustable Wrench



Safety Glasses



Plumber's Putty



Tubing Cutter

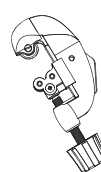

Supply Hoses



INSTALLATION GUIDE: SINGLE HOLE MOUNTED LAVATORY FAUCET

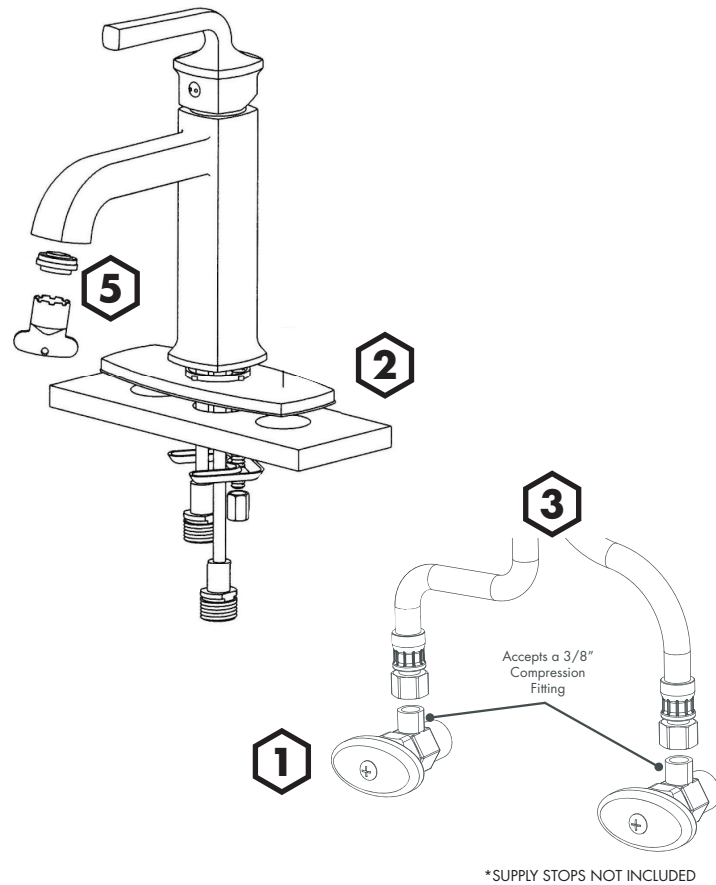

4 POP UP DRAIN ASSEMBLY

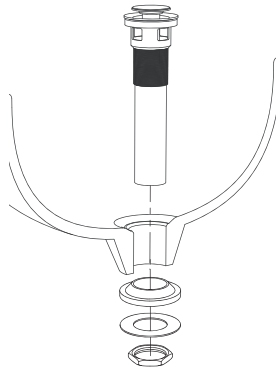

4 LIFT ROD DRAIN ASSEMBLY

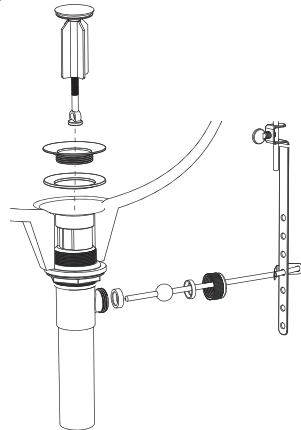

1 TURN OFF WATER SUPPLIES.

2 MOUNT UNIT ON LAVATORY BASIN.
Assemble and secure mounting bracket and nut. (DO NOT OVER TIGHTEN MOUNTING NUT). *Optional: Slide faucet assembly through deck plate first before securing to lavatory basin.

3 ASSEMBLE WATER SUPPLY LINES.
Caution: Use wrench or pliers to hold faucet inlet adapters when tightening supply line nuts to prevent twisting copper tubing or damaging solder joints.

4 PREPARE AND INSTALL POP UP DRAIN ASSEMBLY
When assembling pop-up drain assembly to sink, apply plumbers putty to bottom of flange, silicon sealant between mack washer and threads. Apply thread sealant to tailpiece threads.

OR

4 PREPARE AND INSTALL LIFT ROD DRAIN ASSEMBLY
From beneath, insert Drain Assembly through drain hole in sink. Attach supplied Flange Washer or plumber's putty to the underside of the Flange. Secure Flange to the Drain Assembly. From beneath, tighten mounting nut. Place one end of Spring Clip, on Pivot Rod. Insert Pivot Rod through a hole in the Lift Rod Strap. Secure with Spring Clip. Place Drain into the open position by pressing downward on the Pivot Rod. Insert Lift Rod into Strap. Adjust height of Lift Rod, and tighten Thumb Screw.

5 TURN ON WATER AND FLUSH THE SYSTEM.
Remove aerator (if installed) using aerator key and flush thoroughly to remove any debris. Re-install aerator.

6 CONFIRM PROPER INSTALLATION
Check for leaks and proper operation of faucet.



CALIFORNIA PROPOSITION 65:

WARNING: This product can expose you to chemicals including lead, which is known to the State of California to cause cancer and birth defects or other reproductive harm. For more information go to [www. P65Warnings.ca.gov](http://www.P65Warnings.ca.gov).

Wash hands after installation, repair, or removal of this product.